



690

TECHNICAL SPECIFICATION SHEET



BATTERY CODE	690
BATTERY TYPE	Low Maintenance
VOLTAGE	12
PRODUCT INFORMATION:	<ul style="list-style-type: none"> * Enhanced Flooded Battery (EFB) * Calcium Calcium Silvernano Tech * Automotive Application

Product Specifications:

20 Hour Cn(Ah)	Reserve Cr,n(min)	(IEC/SAE) CCA(A)	Wet Weight (Kg)
140	265	945	42

Dimensions:

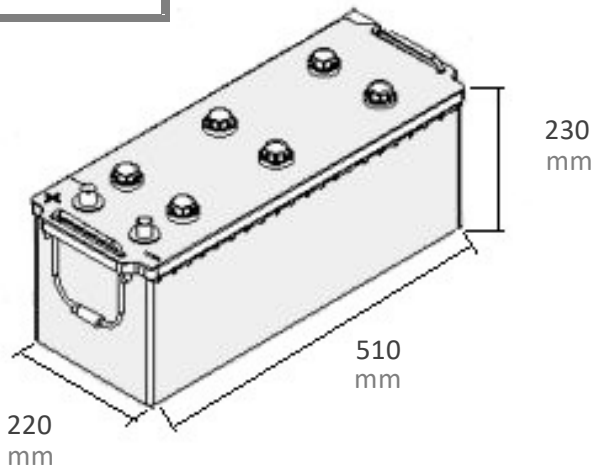

Terminal Type and Layout

STANDARD TAPER TERMINAL / TYPE A



Hold Down:

B0 - No bottom hold downs.

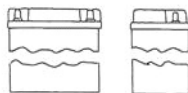

Special Features:

- Polypropylene Container: YES
- Handles: YES
- Centrally Vented Cover:
- One Piece Din Type Cover:

TERMINOLOGY:

CCA/SAE (Is): Cold Cranking Amperes (CCA) is the constant discharge current in Amperes, which the battery can supply at -18°C for 30 seconds before the voltage drops below 1.2 volts per cell (7.2 volts for 12 volt battery).

Reserve Capacity (Cr.n): Is the time in minutes for which the battery can maintain a constant discharge current of 25A before the final voltage drops below 10.5 V at 25 ± 2°C.

Cn: Is the nominal electric discharge (Ah) which the battery can supply with a constant current for a period of 20 hours before the final voltage drops below 1.75 volts per cell (10.5V for 12 volt battery) at 25 ± 2°C.

